

FS-S4601D

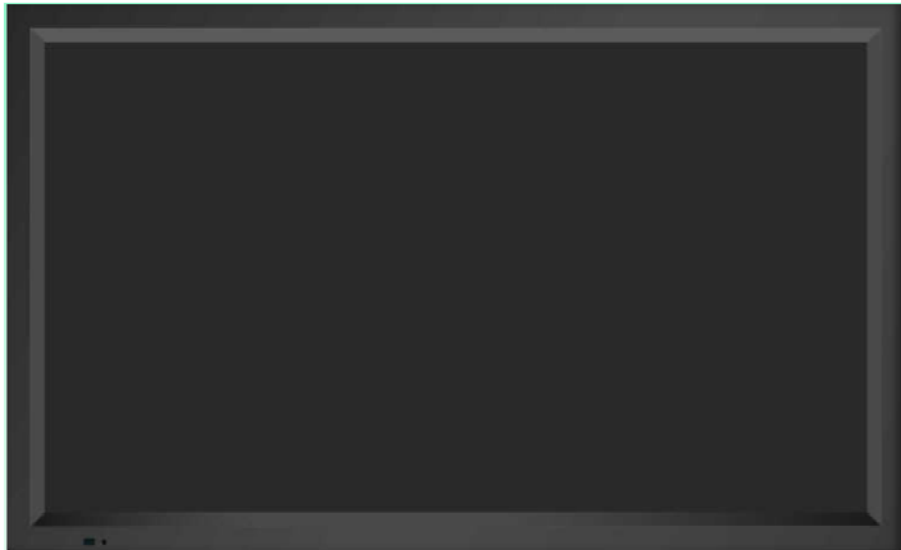

PROPRIETARY NOTE

THIS DOCUMENT CONTAINS INFORMATION CONFIDENTIAL AND PROPRIETARY TO D&T CORPORATION AND SHALL NOT BE REPRODUCED OR TRANSFERRED TO OTHER DOCUMENTS OR DISCLOSED TO OTHERS OR USED FOR ANY PURPOSE OTHER THAN THAT FOR WHICH IT WAS OBTAINED WITHOUT THE EXPRESSED AND WRITTEN CONSENT OF D&T CORPORATION.

APPROVAL		
DRAWN	CHECKED	APPROVED
Mar 15, 2010		

TABLE OF CONTENTS

1. Overview -----	3
1.1 Scope	
1.2 Revision History	
2. General Features -----	4
2.1 General Description	
3. Product Specifications -----	5
3.1 Electrical Specifications	
3.2 Entire System Block Diagram	
3.3 Environmental and Reliability	
3.4 Reliability specification	
4. Regulatory -----	14
5. OSD specification -----	15
5.1 OSD User functions/ Messages	
5.2 OSD representation	
6. Mechanical specification -----	18
6.1 Product dimension	
6.2 VESA Mount	
6.3 Label dimension	
7. Packing -----	21
7.1 Packing	

2. General Features

2.1 General Description

Item		Description
Model		FS-S4601D
LCD Panel	Description	LTI460HA01 (Samsung Display)
	Resolution	1920 x 1080 pixel
Scalar		MST67889ELD-LF-3
Input Signal		1 x DVI/HDMI(DVI 24P connector) 1 x D-SUB 1 x CVBS * 1 x S-VIDEO * 1 x COMPONENT *
User Controls		8 Buttons OSD control Remote control * RS232 Control FAN Control * Temperature sensor control * Light sensor control *
Output Signal		1 x VGA *
Power Supply		SMPS (AC 100~240V)
Control Key		Power, Menu, Ok, Up, Down, Plus, Minus, Source
Board Dimension		Main : 155 x 140 (mm) I/O : 140 x 35 (mm) Keypad : 165 x 24 (mm) Temperature sensor : T.B.D Light sensor : T.B.D
Unit Dimension		1140.9(W) x 695.5(H) x 104(D) (mm)

* It will be option.

3. Product Specification

3.1 Electrical Specifications

3.1.1 Panel

Item	Description	Unit
Description	LTI460HA01 (Samsung LCD)	-
Size	40" Diagonal	Inch
Pixel Pitch	0.53025(H) x 0.53025(H)	mm
Active area	1018.08 x 572.67	mm
Surface Treatment	Haze 44%, Hard-coating(3H)	
Number of Pixels	1920 x 1080	pixel
Pixel Arrangement	RGB Vertical stripe	-
Number of Colors	16,777,216	colors
Contrast Ratio	3500 : 1	Typical
Viewing Angle (CR>10)	89	Degree
Response Time (CR≥ 10)	Rise time (Tr) : 10 Fall time (Tf) : 6	ms , Typical
Surface Luminance	450	cd/ m2
Display mode	Normally black	
Panel Dimension	1083.0(H) x 627.0(V) x 57.5(Dmax)	mm, Typical
Weight	13,000(Max)	g , Typical

3.1.2 Power supply

Item		Specification			
		Min	Typ	Max	Unit
Model No		SLS0627D04018LF			
Description		SMPS(AC/DC Power transfer device) x 1EA			
Input	Rated Voltage	100		240	Vac, Normal
	Voltage Range	90		264	Vac
	Rated Line Frequency	50		60	Hz
	Line Frequency Range	47		63	Hz
	Current	4.6 A max at 100Vac / 2.1A max at 240Vac			
Output	Protection	1, Over current condition : a, When over current the power latch off : +12V/7A max, 24V/18A max b, When over current the power auto recovery : +5V/7A max 2, Over voltage condition : a, When over voltage the power latch off : +12V/16V max, +24V/32V max b, When over voltage the power auto recovery : +5V, +5Vsb/8.5V max			
	Voltage/Current	1, +5Vsb : 0.1A~2A / 4.75V ~ 5.25V12 2, +5V : 0.1A~3A / 4.75V~5.25V 3, +12V : 0.1A~3A / 11.4V~12.6V 4, +24V : 0.1A~10A / 22.8V~25.2V 5, +24V : 0.1A~2A / 22.8V~25.2V			
Operating Temperature		0		40	°C
Storage Temperature		-20		80	°C
Humidity		20		80	%

3.1.3 Power management

This monitor saves energy by switching your monitor into a low power mode when it has not detected a video signal for approximately 10 seconds.

State	Normal Operation	DPMS Standby	DPMS suspend	POWER Off
Horizontal Sync	Active	Inactive	Active	Inactive
Vertical Sync	Active	Active	Inactive	Inactive
Video	Active	Blanked	Blanked	Blanked
Power Indicator	T.B.D	T.B.D	T.B.D	T.B.D
Power Consumption	T.B.D	T.B.D	T.B.D	T.B.D

NOTE : This monitor automatically returns to normal operation when horizontal and vertical sync return. This occurs when a video signal is detected.

3.1.4 Input Signal

Input Signal		Type	Description
VGA	Video	Type	Analog RGB
		Connector	DSUB-15
		Level	0.7Vp-p \pm 5%
		Polarity	Positive
		Impedance	75 ohm \pm 5%
		Horizontal frequency	30 ~ 93KHz
		Vertical frequency	50 ~ 85Hz
		Applicable maximum pixel frequency	170MHz
		Maximum resolution	1920x1200 / 60Hz (154MHz Timing, NON-CRT)
	Sync	Type	Separate H/V sync, Composite H/V sync, Sync On Green Automatic synchronization without external switch
		Level	TTL Level (V high \geq 2.0V, V low \leq 0.8V)
		Polarity	Positive or Negative
		Range	Automatic synchronization for applicable resolution modes which follows industrial standard within frequency range of 30 to 93KHz in horizontal and 50 to 85Hz in vertical
		Terminal resistance	more than 2K Ω
DVI	Type	Digital RGB	
	Signal Format	TMDS single link	
	Connector	DVI-D	
CVBS	Type	C-Video	
	Color system	NTSC, PAL	
	Signal Format	Composite Video Signal	
SVHS Y/C	Type	S-Video	
	Color system	NTSC, PAL	
	Signal Format	Y/C Separated Video Signal	

3.1.5 Output Signal

Output Signal	Type	Description
VGA	Type	Analog RGB
	Signal Format	Analog R,G,B,H,V
	Connector	DSUB-15

3.1.6 Input Signal Timing

Resolution	Horizontal Frequency(KHz)	Vertical Frequency(Hz)	Pixel clock (MHz)
640 x 480 @60Hz	31.469	59.940	25.175
640 x 480 @66Hz	31.500	59.900	25.175
640 x 480 @72Hz	37.861	72.809	31.500
640 x 480 @75Hz	37.500	75.000	31.500
800 x 600 @56Hz	35.156	56.250	36.000
800 x 600 @60Hz	37.879	60.317	40.000
800 x 600 @70Hz	37.879	60.317	40.000
800 x 600 @72Hz	48.077	72.188	50.000
800 x 600 @75Hz	46.875	75.000	49.500
1024 x 768 @60Hz	48.363	60.004	65.000
1024 x 768 @70Hz	56.476	70.069	75.000
1024 x 768 @72Hz	57.900	71.800	75.000
1024 x 768 @75Hz	60.023	75.029	78.750
1152 x 864 @60Hz	54.348	60.053	80.000
1152 x 864 @70Hz	63.955	70.016	94.200
1152 x 864 @72Hz	65.100	70.200	94.200
1152 x 864 @75Hz	67.500	75.000	108.000
1280 x 960 @60Hz	60.000	60.000	108.000
1280 x 960 @70Hz	70.000	70.000	148.500
1280 x 960 @72Hz	72.000	72.000	148.500
1280 x 960 @75Hz	75.000	75.000	148.500
1280 x 1024 @60Hz	63.974	60.013	108.500
1280 x 1024 @70Hz	74.400	70.000	135.000
1280 x 1024 @72Hz	78.000	72.000	135.000
1280 x 1024 @75Hz	80.000	75.000	135.000
1600 x 1200 @60Hz	75.000	60.000	162.000
1920 x 1080 @60Hz	67.500	60.000	148.500

3.2 Entire System Block Diagram

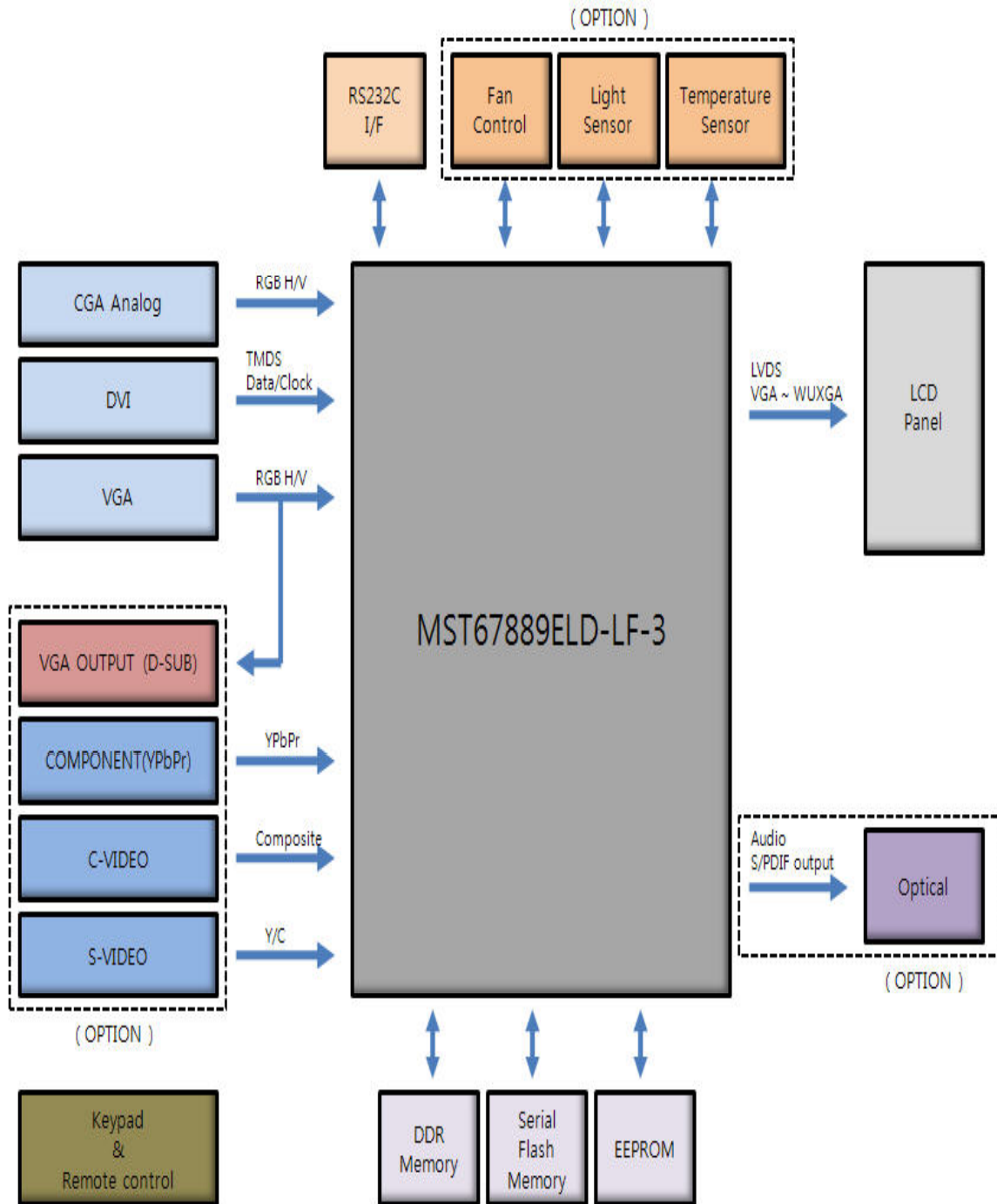

3.3 Environmental specification

Item		Description
Operating Conditions	Temperature	0 °C ~ 40 °C
	Humidity	5% ~ 85%, non-condensing
Transportation Conditions	Temperature	-20 °C ~ 60 °C
	Humidity	5% ~ 95%, non-condensing
Storage Conditions	Temperature	-20 °C ~ 60 °C
	Humidity	10% ~ 85%, non-condensing

3.4 Reliability specification

MTBF : 50,000 hours

Reliability items :

3.4.1 Stress / Time acceleration Test

3.4.2 Temperature Cycle Test



4. Regulatory

5. OSD Specification

FS-S4601D gives various and very easy graphic user interface. User can easily access function. 8 button keypad, located on the front of monitor, allows the user to make adjustments to various display parameters using on screen menus easily.

Be sure that your system power and LED is turned on before operating key board.

5.1 OSD User functions/ Messages

5.1.1 OSD indicator

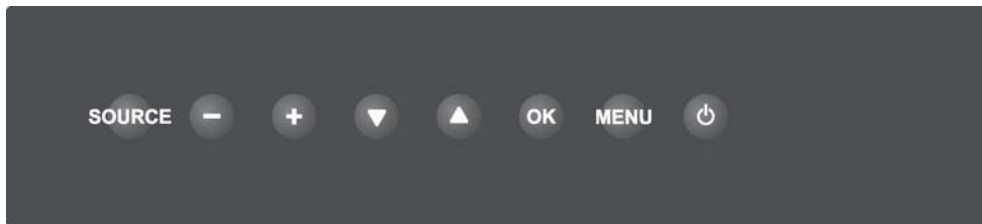

Key Name	Description
Power	Soft power Turns ON/OFF the monitor.
Menu	- With OSD deactivated, Activated to OSD menu. - With OSD activated, Exit from main menu or sub menu.
OK	Auto adjust.
UP (▲)	- With OSD deactivated, Hot key of the brightness control and increases the brightness. - With OSD activated, move the OSD cursor upward.
Down (▼)	- With OSD deactivated, Hot key of the brightness control and decreases the brightness. - With OSD activated, move the OSD cursor downward.
Plus (+)	- With OSD deactivated, Hot key of the contrast control and increases the contrast. - With OSD activated, enter sub menu and increases the adjustment of the selected function.
Minus (-)	- With OSD deactivated, Hot key of the contrast control and decreases the contrast. - With OSD activated, decreases the adjustment of the selected function.
Source	Change the display signal source. -Select RGB / C-VIDEO / S-VIDEO / YPbPr / DVI -With OSD deactivated, Hot key of the auto adjustment control when it pressed over 1 second at DSUB ANALOG source.

* It will be updated later.

5.2 OSD representation

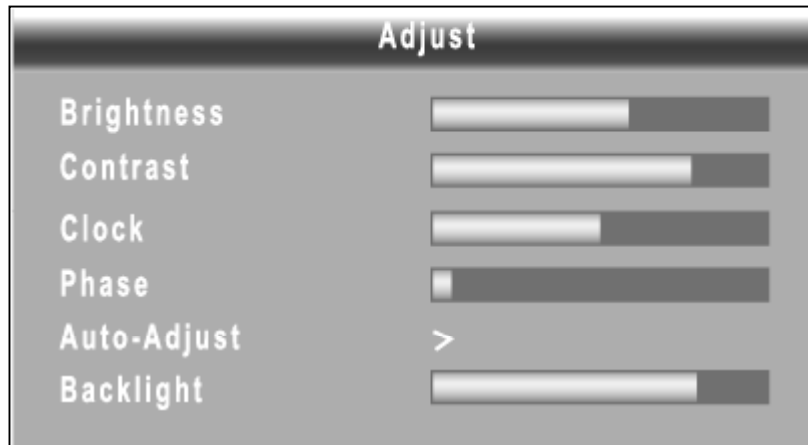

Menus	Sub-menus	Function Descriptions
Adjust	Brightness	Increase or decrease the brightness (Range : 0~100)
	Contrast	Increase or decrease the contrast (Range : 0~100)
	Clock	Increase or decrease the sampling frequency (Range : 0~100)
	Phase	Increase or decrease the Phase level (Range : 0~100)
	Auto-Adjust	Fit to the most appropriate screen on the D-SUB Analog signal
	Backlight	Adjust backlight dimming level (Range : 0~100)

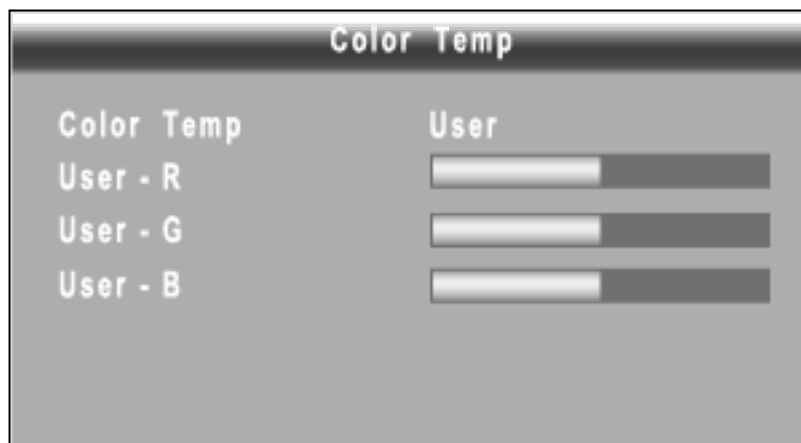

Menus	Sub-menus	Function Descriptions
Color Temp	Color Temp	Change the color temperature mode (6500K, 5600K, USER)
	User-R	Red balance (Only works with USER mode) (Range : 0~100)
	User-G	Green balance (Only works with USER mode) (Range : 0~100)
	User-B	Blue balance (Only works with USER mode) (Range : 0~100)



Menus	Sub-menus	Function Descriptions
Image	Image Size	Change the image size (Full, Fill aspect, 1:1, Normal)
	H-Position	Adjust the horizontal position of the displayed source image. (Range : 0~100)
	V-Position	Adjust the vertical position of the displayed source image. (Range : 0~100)
	Sharpness	Set the sharpness of image (Softest, Soft, Normal, Sharp, Sharpest)
	Over Scan	Adjust the displayed size.
	Freeze	Keep still the image

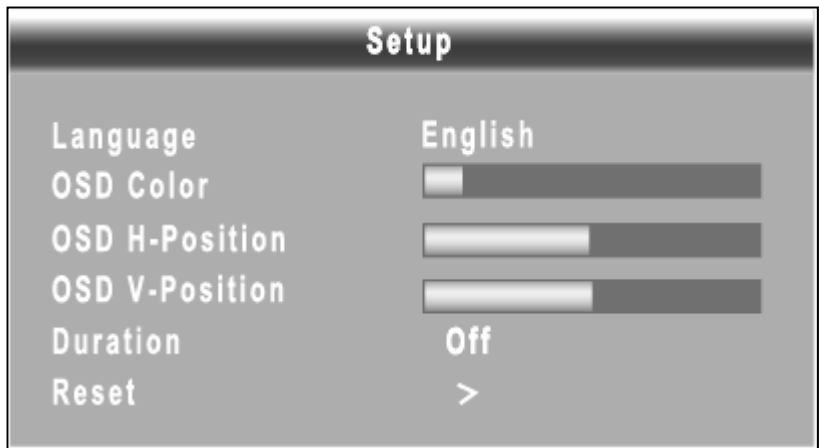

Menus	Sub-menus	Function Descriptions
SetUp	Language	Change the OSD language .
	OSD Color	Change the OSD transparency.
	OSD H-Position	Change the OSD horizontal position .
	OSD V-Position	Change the OSD vertical position .
	Duration	Adjust time until the OSD Menu will disappear after adjusting the menu. (5, 10, 20, 30, 60, 90, 120, 180, 240 seconds)
	Reset	Changes the all OSD value to factory outgoing status.

6. Mechanical Specifications

6.1 Product dimension

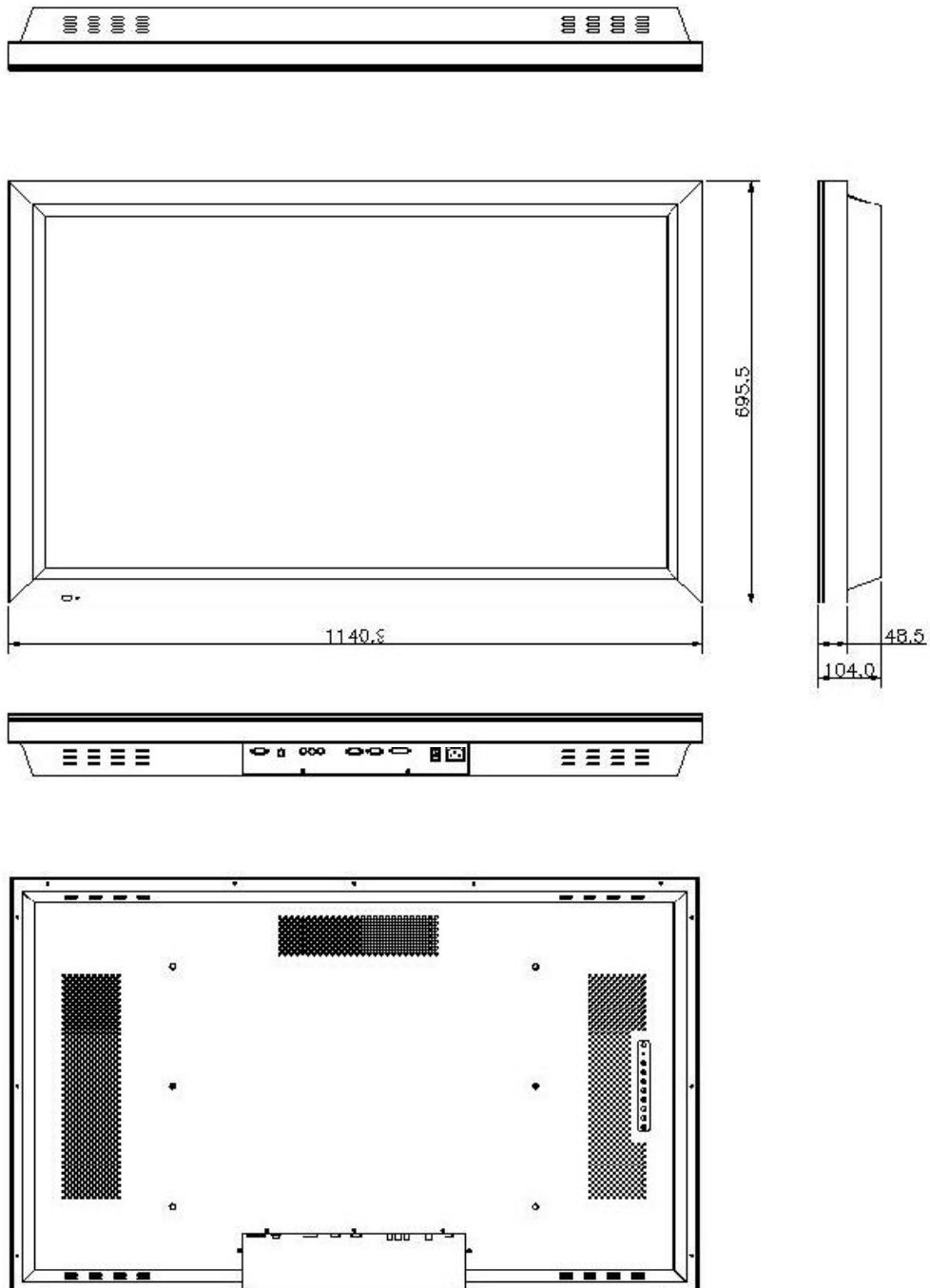

6.3 Label dimension

6.3.1 Connector (Function) label

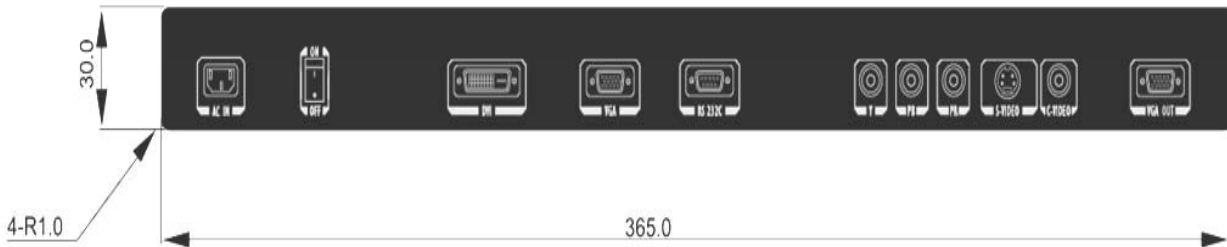

6.3.2 Keypad label

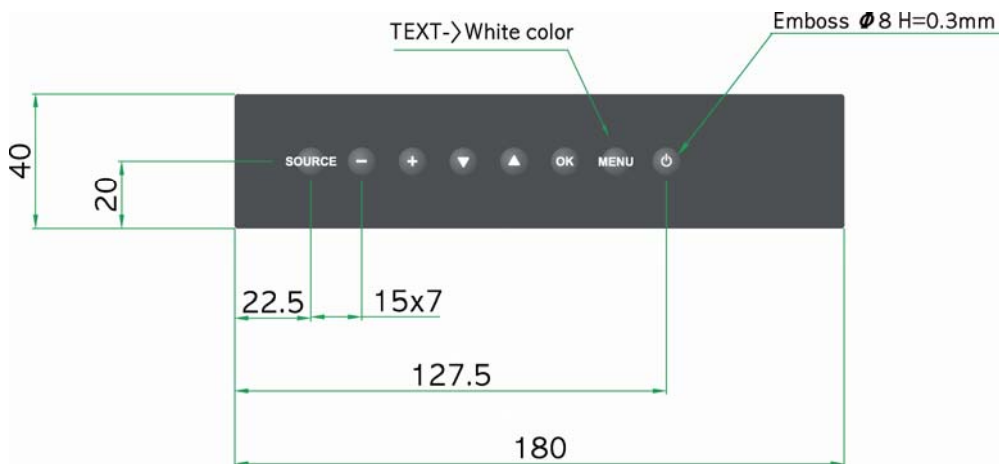

6.3.3 Product label

Brand Logo	FORESEESON	
Model NO.	FS-S4601D	
Rating Label (This may vary based on the Customer's request, and the changed contents of the Rating Label shall not be specified in this specification.)	Location	The left bottom side of rear-cover
	Tilt	Shall not be tilted more than 1mm
	Size	
	Material	Polyester film (75Demicron)
	Base Color	The color same as rear housing(Gray)

6.3.4 BOX label

7. Packing

7.1 Packing

7.1.1 Carton Dimension(T.B.D)

Item	Width	Depth	Height
Dimension	T.B.D	T.B.D	T.B.D

7.1.2 Unit Weight

Net Weight (1 unit product)		Gross Weight (1 unit product)	
Kg	lbs	Kg	lbs
33	72.8	36	79.4

7.1.3 Accessory(T.B.D)