

# FS-S5203D

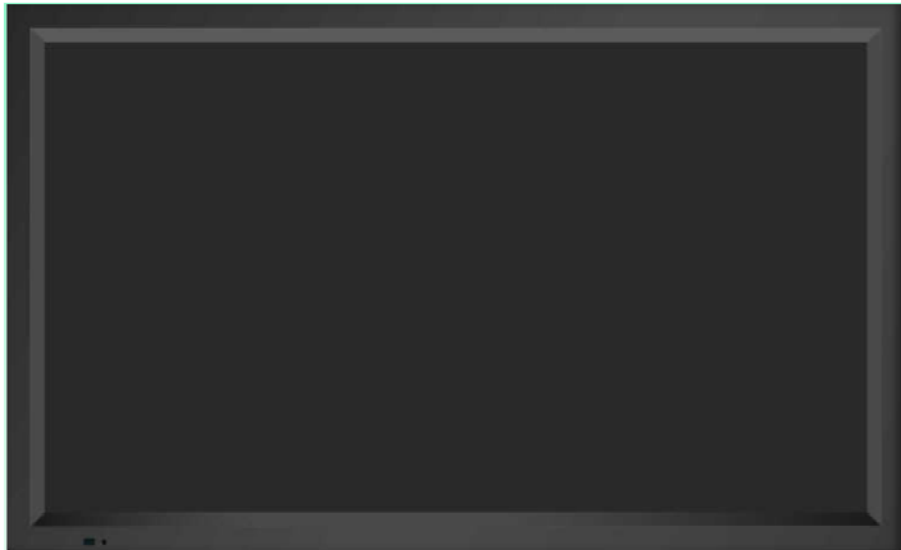

## PROPRIETARY NOTE

THIS DOCUMENT CONTAINS INFORMATION CONFIDENTIAL AND PROPRIETARY TO D&T CORPORATION AND SHALL NOT BE REPRODUCED OR TRANSFERRED TO OTHER DOCUMENTS OR DISCLOSED TO OTHERS OR USED FOR ANY PURPOSE OTHER THAN THAT FOR WHICH IT WAS OBTAINED WITHOUT THE EXPRESSED AND WRITTEN CONSENT OF D&T CORPORATION.

APPROVAL		
DRAWN	CHECKED	APPROVED
Mar 15, 2010		

# TABLE OF CONTENTS

1. Overview -----	3
1.1 Scope	
1.2 Revision History	
2. General Features -----	4
2.1 General Description	
3. Product Specifications -----	5
3.1 Electrical Specifications	
3.2 Entire System Block Diagram	
3.3 Environmental and Reliability	
3.4 Reliability specification	
4. Regulatory -----	14
5. OSD specification -----	15
5.1 OSD User functions/ Messages	
5.2 OSD representation	
6. Mechanical specification -----	18
6.1 Product dimension	
6.2 VESA Mount	
6.3 Label dimension	
7. Packing -----	21
7.1 Packing	

# 1. Overview

## 1.1 Scope

FS-S5203D product has been specifically designed to use DID applications. This system have high performance, touch enabled LCD display. The LCD display feature high brightness and high resolution to deliver an eye-catching display solution at a lower cost.

## 1.2 Revision History

Date	Revision	Change Description
Mar 10, 2010	1.0	Preliminary release.
Mar 15, 2010	1.1	- Gross weight of product updated.

## 2. General Features

### 2.1 General Description

Item		Description
<b>Model</b>		FS-S5203D
<b>LCD Panel</b>	<b>Description</b>	LTI520HB02 (Samsung Display)
	<b>Resolution</b>	1920 x 1080 pixel
<b>Scalar</b>		MST67889ELD-LF-3
<b>Input Signal</b>		1 x DVI/HDMI(DVI 24P connector) 1 x D-SUB 1 x CVBS * 1 x S-VIDEO * 1 x COMPONENT *
<b>User Controls</b>		8 Buttons OSD control Remote control * RS232 Control FAN Control * Temperature sensor control * Light sensor control *
<b>Output Signal</b>		1 x VGA *
<b>Power Supply</b>		SMPS (AC 100~240V)
<b>Control Key</b>		Power, Menu, Ok, Up, Down, Plus, Minus, Source
<b>Board Dimension</b>		Main : 155 x 140 (mm) I/O : 140 x 35 (mm) Keypad : 165 x 24 (mm) Temperature sensor : T.B.D Light sensor : T.B.D
<b>Unit Dimension</b>		1274.8(W) x 770.8(H) x 104(D) (mm)

\* It will be option.

## 3. Product Specification

### 3.1 Electrical Specifications

#### 3.1.1 Panel

Item	Description	Unit
Description	LTI520HB02 (Samsung LCD)	-
Size	52" Diagonal	Inch
Pixel Pitch	0.6(H) x 0.6(H)	mm
Active area	1152.0 x 648.0	mm
Surface Treatment	Haze 44%, Hard-coating(3H)	
Number of Pixels	1920 x 1080	pixel
Pixel Arrangement	RGB Vertical stripe	-
Number of Colors	16,777,216	colors
Contrast Ratio	3000 : 1	Typical
Viewing Angle (CR>10)	89	Degree
Response Time (CR≥ 10)	Rise time (Tr) : 14 Fall time (Tf) : 8	ms , Typical
Surface Luminance	500	cd/ m2
Display mode	Normally black	
Panel Dimension	1226.0(H) x 719.2(V) x 60.0(Dmax)	mm, Typical
Weight	19,000(Max)	g , Typical

### 3.1.2 Power supply

Item		Specification			
		Min	Typ	Max	Unit
<b>Model No</b>		SLS0627D04018LF			
<b>Description</b>		SMPS(AC/DC Power transfer device) x 2EA			
<b>Input</b>	<b>Rated Voltage</b>	100		240	Vac, Normal
	<b>Voltage Range</b>	90		264	Vac
	<b>Rated Line Frequency</b>	50		60	Hz
	<b>Line Frequency Range</b>	47		63	Hz
	<b>Current</b>	4.6 A max at 100Vac / 2.1A max at 240Vac			
<b>Output</b>	<b>Protection</b>	1, Over current condition : a, When over current the power latch off : +12V/7A max, 24V/18A max b, When over current the power auto recovery : +5V/7A max 2, Over voltage condition : a, When over voltage the power latch off : +12V/16V max, +24V/32V max b, When over voltage the power auto recovery : +5V, +5Vsb/8.5V max			
	<b>Voltage/Current</b>	1, +5Vsb : 0.1A~2A / 4.75V ~ 5.25V12 2, +5V : 0.1A~3A / 4.75V~5.25V 3, +12V : 0.1A~3A / 11.4V~12.6V 4, +24V : 0.1A~10A / 22.8V~25.2V 5, +24V : 0.1A~2A / 22.8V~25.2V			
<b>Operating Temperature</b>		0		40	°C
<b>Storage Temperature</b>		-20		80	°C
<b>Humidity</b>		20		80	%

### 3.1.3 Power management

This monitor saves energy by switching your monitor into a low power mode when it has not detected a video signal for approximately 10 seconds.

<b>State</b>	<b>Normal Operation</b>	<b>DPMS Standby</b>	<b>DPMS suspend</b>	<b>POWER Off</b>
Horizontal Sync	Active	Inactive	Active	Inactive
Vertical Sync	Active	Active	Inactive	Inactive
Video	Active	Blanked	Blanked	Blanked
Power Indicator	T.B.D	T.B.D	T.B.D	T.B.D
Power Consumption	T.B.D	T.B.D	T.B.D	T.B.D

NOTE : This monitor automatically returns to normal operation when horizontal and vertical sync return. This occurs when a video signal is detected.

### 3.1.4 Input Signal

Input Signal		Type	Description
VGA	Video	Type	Analog RGB
		Connector	DSUB-15
		Level	0.7Vp-p $\pm$ 5%
		Polarity	Positive
		Impedance	75 ohm $\pm$ 5%
		Horizontal frequency	30 ~ 93KHz
		Vertical frequency	50 ~ 85Hz
		Applicable maximum pixel frequency	170MHz
		Maximum resolution	1920x1200 / 60Hz (154MHz Timing, NON-CRT)
	Sync	Type	Separate H/V sync, Composite H/V sync, Sync On Green Automatic synchronization without external switch
		Level	TTL Level (V high $\geq$ 2.0V, V low $\leq$ 0.8V)
		Polarity	Positive or Negative
		Range	Automatic synchronization for applicable resolution modes which follows industrial standard within frequency range of 30 to 93KHz in horizontal and 50 to 85Hz in vertical
Terminal resistance		more than 2K $\Omega$	
DVI	Type	Digital RGB	
	Signal Format	TMDS single link	
	Connector	DVI-D	
CVBS	Type	C-Video	
	Color system	NTSC, PAL	
	Signal Format	Composite Video Signal	
SVHS Y/C	Type	S-Video	
	Color system	NTSC, PAL	
	Signal Format	Y/C Separated Video Signal	

### 3.1.5 Output Signal

Output Signal	Type	Description
VGA	Type	Analog RGB
	Signal Format	Analog R,G,B,H,V
	Connector	DSUB-15



### 3.1.6 Input Signal Timing

Resolution	Horizontal Frequency(KHz)	Vertical Frequency(Hz)	Pixel clock (MHz)
<b>640 x 480 @60Hz</b>	31.469	59.940	25.175
<b>640 x 480 @66Hz</b>	31.500	59.900	25.175
<b>640 x 480 @72Hz</b>	37.861	72.809	31.500
<b>640 x 480 @75Hz</b>	37.500	75.000	31.500
<b>800 x 600 @56Hz</b>	35.156	56.250	36.000
<b>800 x 600 @60Hz</b>	37.879	60.317	40.000
<b>800 x 600 @70Hz</b>	37.879	60.317	40.000
<b>800 x 600 @72Hz</b>	48.077	72.188	50.000
<b>800 x 600 @75Hz</b>	46.875	75.000	49.500
<b>1024 x 768 @60Hz</b>	48.363	60.004	65.000
<b>1024 x 768 @70Hz</b>	56.476	70.069	75.000
<b>1024 x 768 @72Hz</b>	57.900	71.800	75.000
<b>1024 x 768 @75Hz</b>	60.023	75.029	78.750
<b>1152 x 864 @60Hz</b>	54.348	60.053	80.000
<b>1152 x 864 @70Hz</b>	63.955	70.016	94.200
<b>1152 x 864 @72Hz</b>	65.100	70.200	94.200
<b>1152 x 864 @75Hz</b>	67.500	75.000	108.000
<b>1280 x 960 @60Hz</b>	60.000	60.000	108.000
<b>1280 x 960 @70Hz</b>	70.000	70.000	148.500
<b>1280 x 960 @72Hz</b>	72.000	72.000	148.500
<b>1280 x 960 @75Hz</b>	75.000	75.000	148.500
<b>1280 x 1024 @60Hz</b>	63.974	60.013	108.500
<b>1280 x 1024 @70Hz</b>	74.400	70.000	135.000
<b>1280 x 1024 @72Hz</b>	78.000	72.000	135.000
<b>1280 x 1024 @75Hz</b>	80.000	75.000	135.000
<b>1600 x 1200 @60Hz</b>	75.000	60.000	162.000
<b>1920 x 1080 @60Hz</b>	67.500	60.000	148.500

### 3.2 Entire System Block Diagram

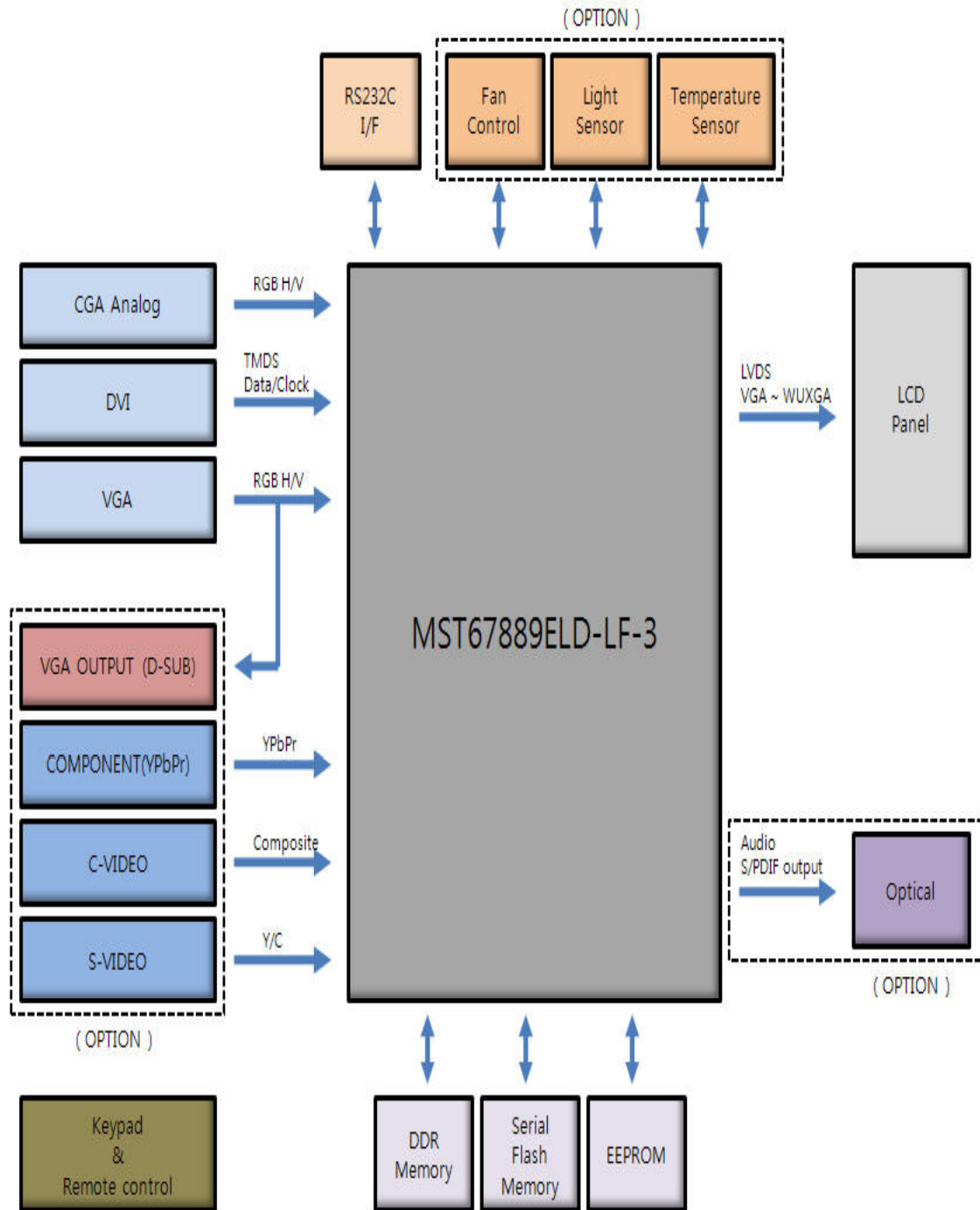

### 3.3 Environmental specification

Item		Description
Operating Conditions	Temperature	0 °C ~ 40 °C
	Humidity	5% ~ 85%, non-condensing
Transportation Conditions	Temperature	-20 °C ~ 60 °C
	Humidity	5% ~ 95%, non-condensing
Storage Conditions	Temperature	-20 °C ~ 60 °C
	Humidity	10% ~ 85%, non-condensing

### 3.4 Reliability specification

**MTBF** : 50,000 hours.

**Reliability items** :

3.4.1 Stress / Time acceleration Test

3.4.2 Temperature Cycle Test



## 4. Regulatory

## 5. OSD Specification

FS-S5203D gives various and very easy graphic user interface. User can easily access function. 8 button keypad, located on the front of monitor, allows the user to make adjustments to various display parameters using on screen menus easily.

Be sure that your system power and LED is turned on before operating key board.

### 5.1 OSD User functions/ Messages

#### 5.1.1 OSD indicator

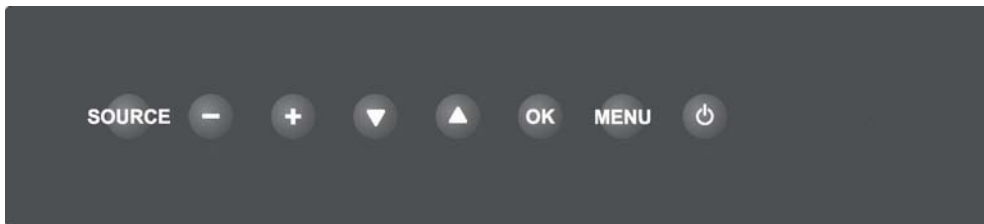

Key Name	Description
<b>Power</b>	Soft power Turns ON/OFF the monitor.
<b>Menu</b>	- With OSD deactivated, Activated to OSD menu. - With OSD activated, Exit from main menu or sub menu.
<b>OK</b>	Auto adjust.
<b>UP (▲)</b>	- With OSD deactivated, <b>Hot key of the brightness control and increases the brightness.</b> - With OSD activated, move the OSD cursor upward.
<b>Down (▼)</b>	- With OSD deactivated, <b>Hot key of the brightness control and decreases the brightness.</b> - With OSD activated, move the OSD cursor downward.
<b>Plus (+)</b>	- With OSD deactivated, <b>Hot key of the contrast control and increases the contrast.</b> - With OSD activated, enter sub menu and increases the adjustment of the selected function.
<b>Minus (-)</b>	- With OSD deactivated, <b>Hot key of the contrast control and decreases the contrast.</b> - With OSD activated, decreases the adjustment of the selected function.
<b>Source</b>	Change the display signal source. -Select RGB / C-VIDEO / S-VIDEO / YPbPr / DVI -With OSD deactivated, <b>Hot key of the auto adjustment control when it pressed over 1 second at DSUB ANALOG source.</b>

\* It will be updated later.

## 5.2 OSD representation

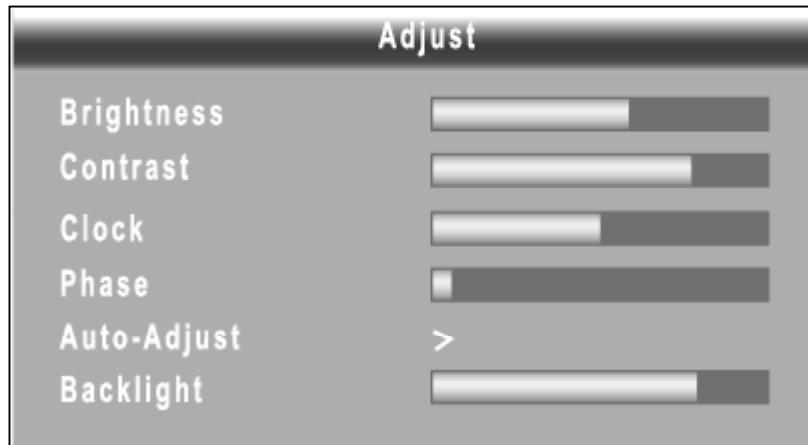

Menus	Sub-menus	Function Descriptions
<b>Adjust</b>	<b>Brightness</b>	Increase or decrease the brightness (Range : 0~100)
	<b>Contrast</b>	Increase or decrease the contrast (Range : 0~100)
	<b>Clock</b>	Increase or decrease the sampling frequency (Range : 0~100)
	<b>Phase</b>	Increase or decrease the Phase level (Range : 0~100)
	<b>Auto-Adjust</b>	Fit to the most appropriate screen on the D-SUB Analog signal
	<b>Backlight</b>	Adjust backlight dimming level (Range : 0~100)

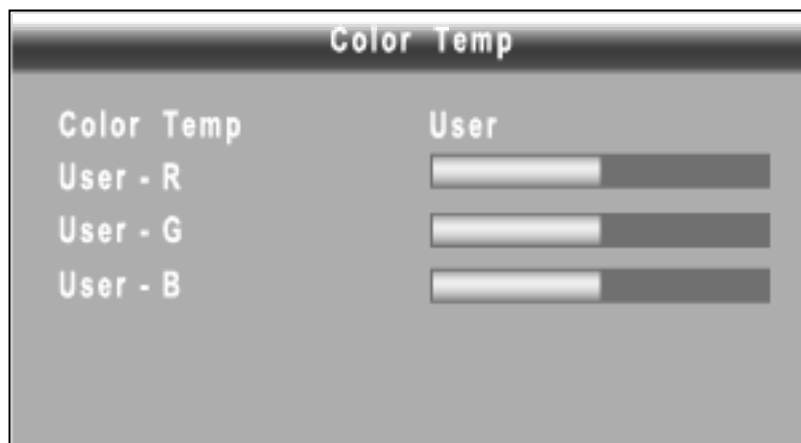

Menus	Sub-menus	Function Descriptions
<b>Color Temp</b>	<b>Color Temp</b>	Change the color temperature mode ( 6500K, 5600K, USER )
	<b>User-R</b>	Red balance (Only works with USER mode) (Range : 0~100)
	<b>User-G</b>	Green balance (Only works with USER mode) (Range : 0~100)
	<b>User-B</b>	Blue balance (Only works with USER mode) (Range : 0~100)



Menus	Sub-menus	Function Descriptions
<b>Image</b>	<b>Image Size</b>	Change the image size (Full, Fill aspect, 1:1, Normal)
	<b>H-Position</b>	Adjust the horizontal position of the displayed source image. (Range : 0~100)
	<b>V-Position</b>	Adjust the vertical position of the displayed source image. (Range : 0~100)
	<b>Sharpness</b>	Set the sharpness of image (Softest, Soft, Normal, Sharp, Sharpest)
	<b>Over Scan</b>	Adjust the displayed size.
	<b>Freeze</b>	Keep still the image

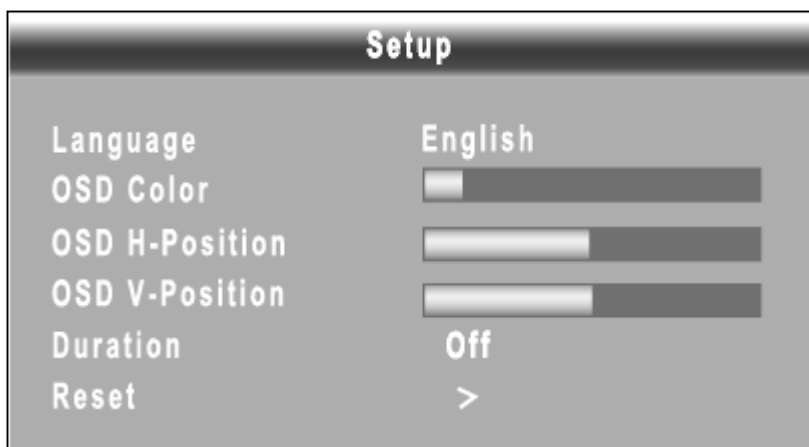

Menus	Sub-menus	Function Descriptions
<b>SetUp</b>	<b>Language</b>	Change the OSD language .
	<b>OSD Color</b>	Change the OSD transparency.
	<b>OSD H-Position</b>	Change the OSD horizontal position .
	<b>OSD V-Position</b>	Change the OSD vertical position .
	<b>Duration</b>	Adjust time until the OSD Menu will disappear after adjusting the menu. (5, 10, 20, 30, 60, 90, 120, 180, 240 seconds)
	<b>Reset</b>	Changes the all OSD value to factory outgoing status.

## 6. Mechanical Specifications

### 6.1 Product dimension

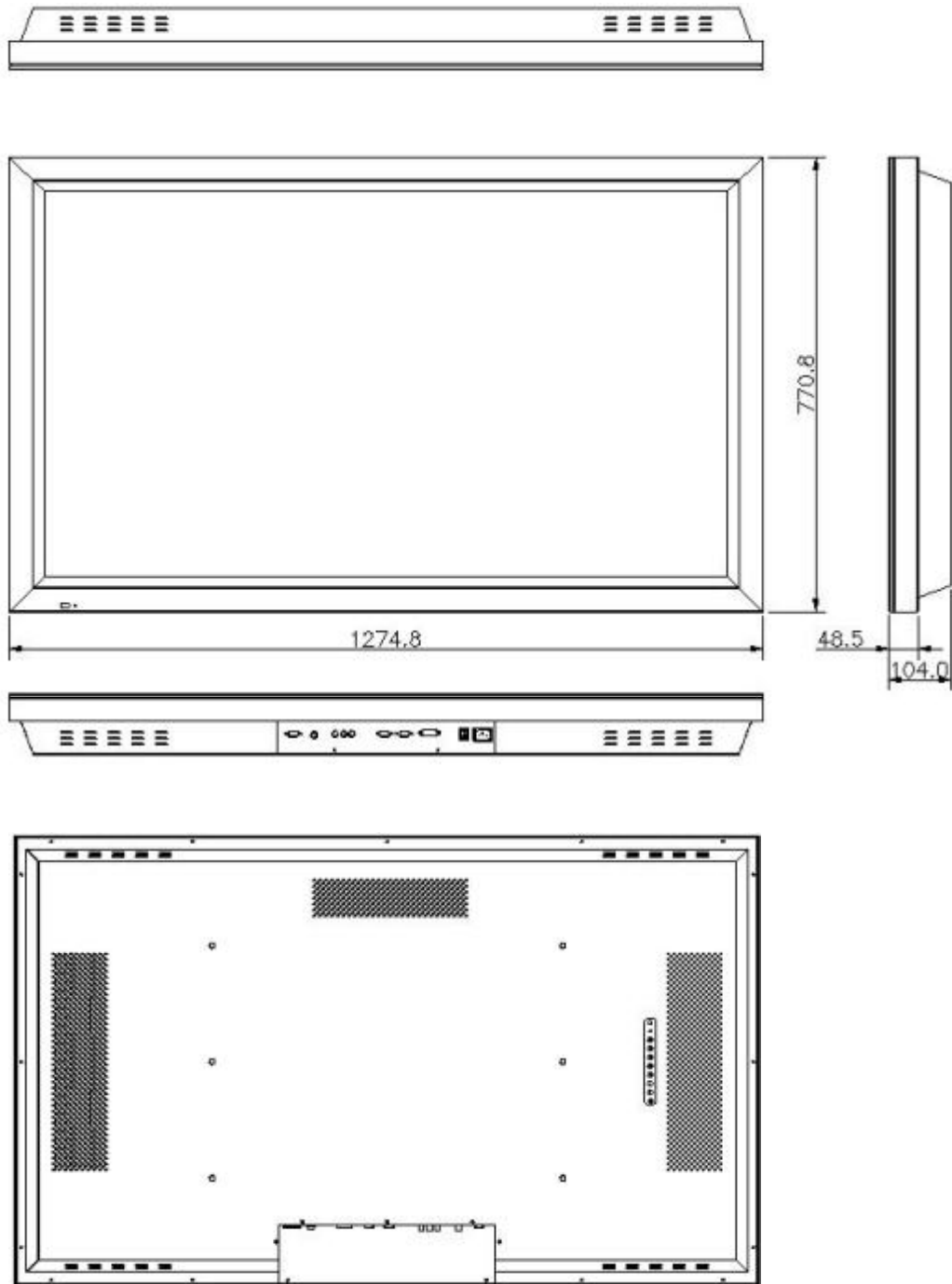



## 6.2 VESA Mount

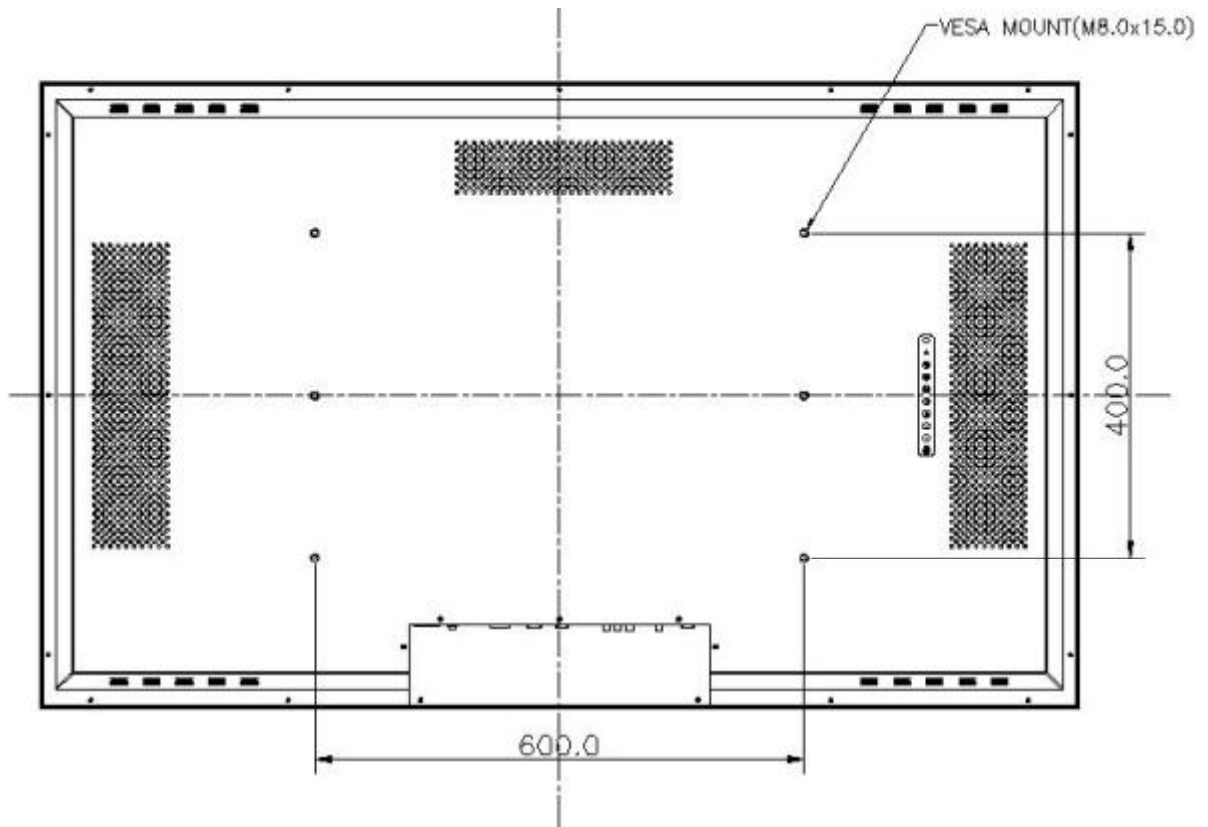

### 6.3 Label dimension

#### 6.3.1 Connector (Function) label

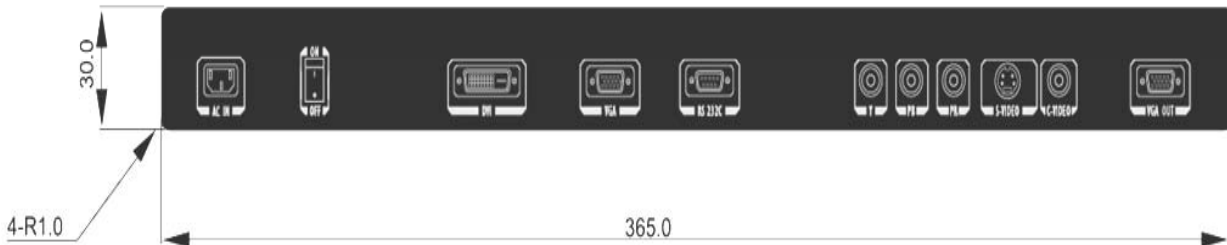

#### 6.3.2 Keypad label

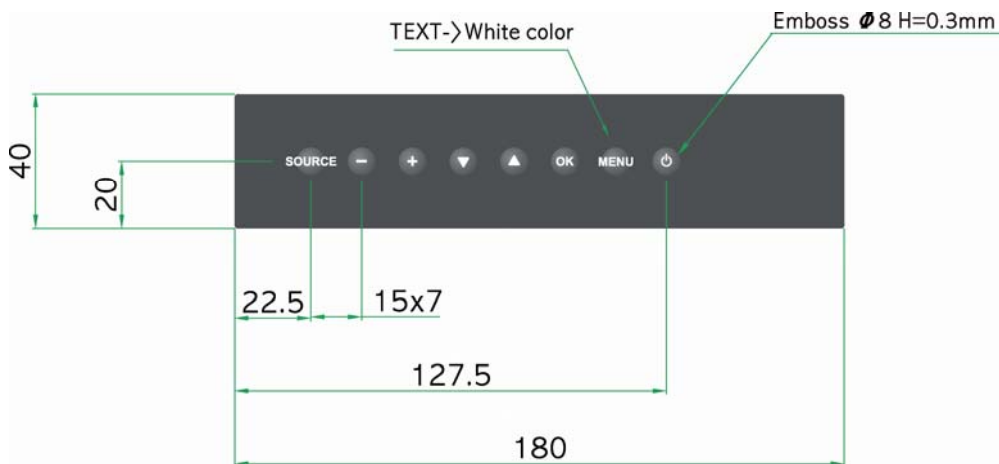

#### 6.3.3 Product label

<b>Brand Logo</b>	FORESEESON	
<b>Model NO.</b>	FS-S5203D	
<b>Rating Label</b> (This may vary based on the Customer's request, and the changed contents of the Rating Label shall not be specified in this specification.)	Location	The left bottom side of rear-cover
	Tilt	Shall not be tilted more than 1mm
	Size	
	Material	Polyester film (75Demicron)
	Base Color	The color same as rear housing(Gray)

#### 6.3.4 BOX label

## 7. Packing

### 7.1 Packing

#### 7.1.1 Carton Dimension(T.B.D)

Item	Width	Depth	Height
Dimension	T.B.D	T.B.D	T.B.D

#### 7.1.2 Unit Weight

Net Weight ( 1 unit product )		Gross Weight ( 1 unit product )	
Kg	lbs	Kg	lbs
45	99.2	49	108.0

#### 7.1.3 Accessory(T.B.D)